

Odgadnij i wpisz wielką lub małą literę. Odczytaj i prawidłowo zapisz hasło.

1		O	R	Z	E	B	A	Ł	T	Y	C	K	I	E
2		N	D	I	E									
3		O	P	E	N	H	A	G	A					
4		L	S	Z	T	Y	N							
5		O	T	W	A									
6		N	G	I	E	L	S	K	I					
7		E	Z	I	O	R	O							
8		R	Ó	L	P	O	P	I	E	L				
9		C	E	A	N									
10		Ó	Ł	W	Y	S	E	P						
11		L	B	L	Ą	G								
12		Y	S	Y										
13		I	A	G	A	R	A							
14		R	L	A	N	D	I	A						
15		U	J	A	W	Y								

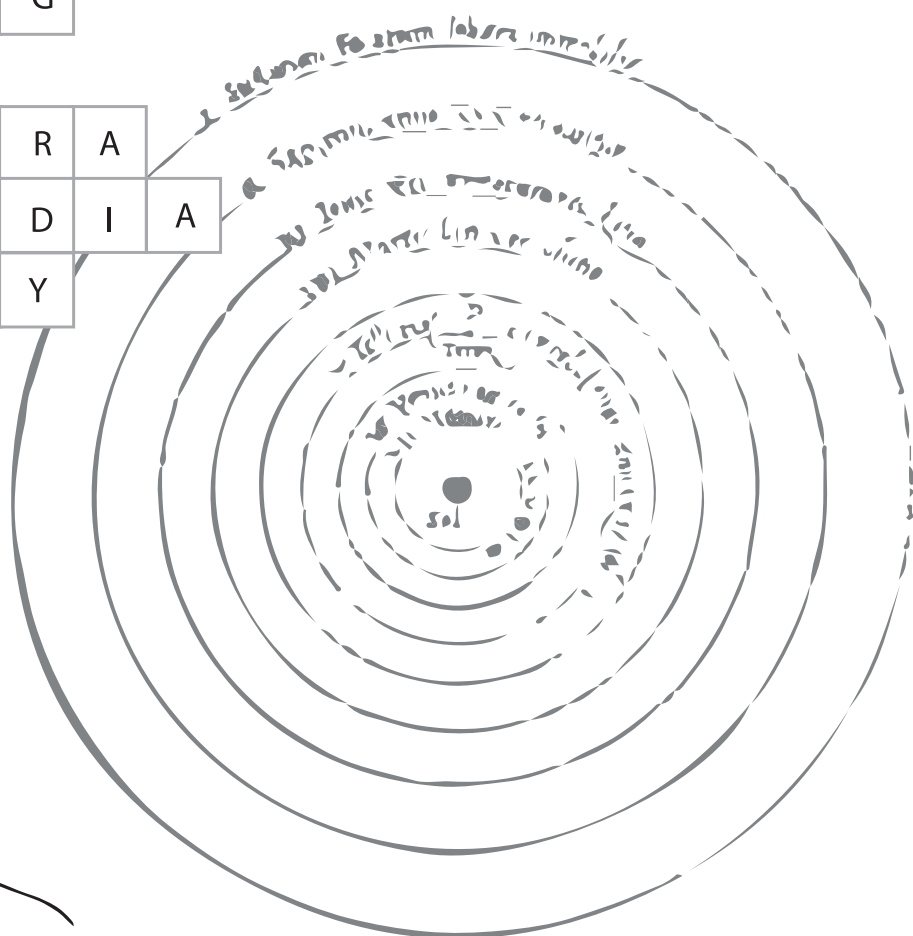

--	--	--	--	--	--	--	--	--	--	--	--	--	--	--	--	--	--	--	--

HASŁO

„A”, „om” czy „on”. „E”, „em” czy „en”.

Rozwiąż krzyżówkę obrazkową. Odczytaj hasło.

Pamiętaj, aby dwuznaki wpisywać w jedno okienko.

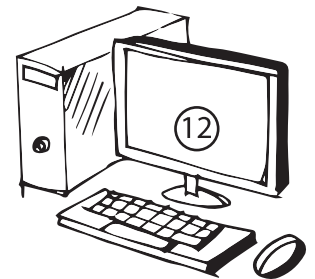
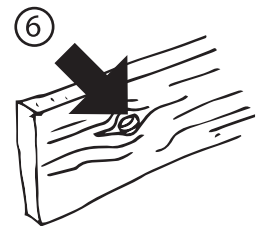
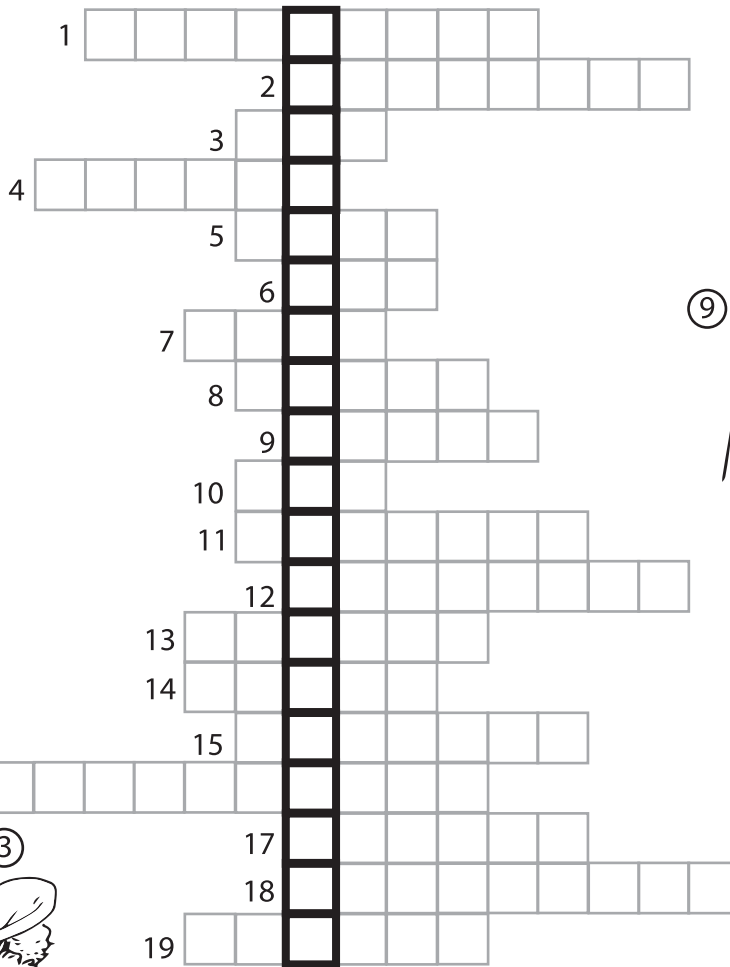
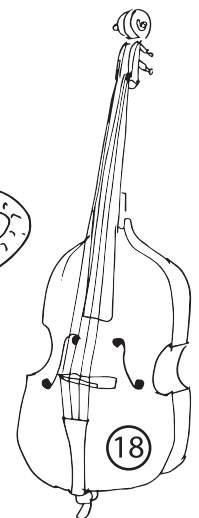
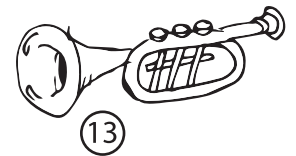
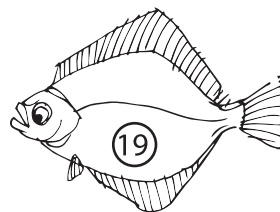
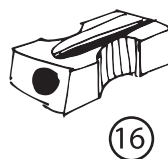
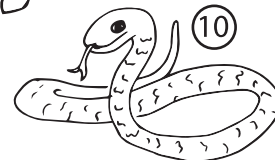
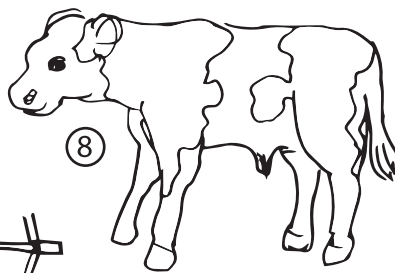
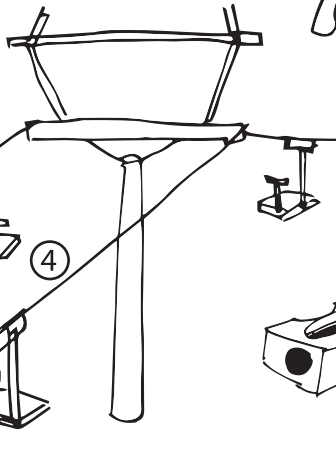
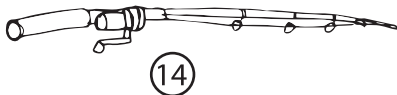

Rozwiąż krzyżówkę i odczytaj hasło.  
Pamiętaj, aby dwuznaki wpisywać w jedno okienko.

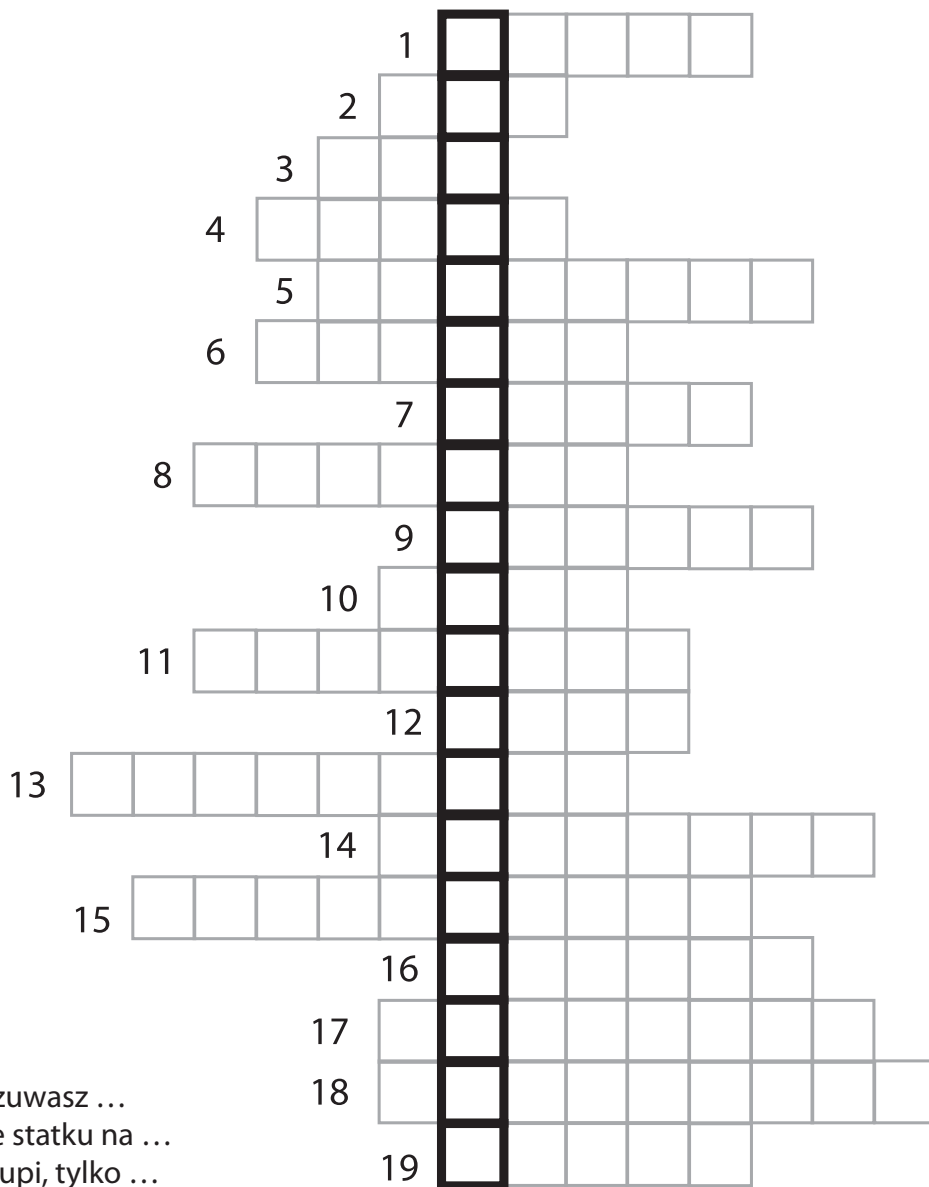
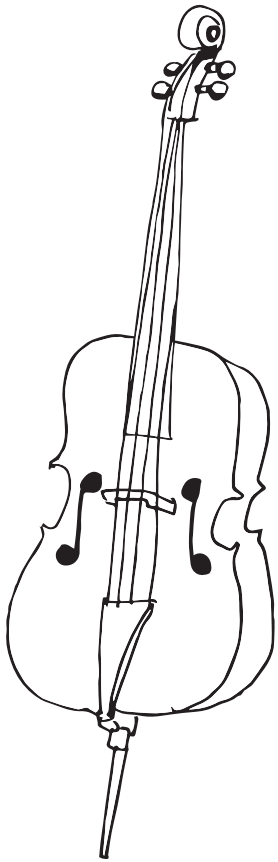

1. Masz go w buzi.
2. Gdy się boisz, odczuwasz ...
3. Marynarz zszedł ze statku na ...
4. Jaś nie chce być głupi, tylko ...
5. Małe dziecko.
6. Kasia zrobiła dla mamy ... bukiet z liści.
7. Ola ma szeroką wstążkę, a Ula ... wstążkę.
8. Wlewasz ją do baku samochodu.
9. Siejesz na niej marchewkę.
10. Bez niego nie działa lodówka ani telewizor.
11. Pani z mieszkania obok.
12. Pełna kwiatów.
13. Ma 2 boki krótsze i 2 boki dłuższe.
14. Inaczej puszka z mięsem.
15. Jest mniejsza od altówki, a większa od kontrabasu.
16. Napój z owocami.
17. Dziecko kury.
18. Najważniejsza osoba w państwie.
19. W sądzie decyduje o winie i wyznacza karę.



--	--	--	--

Odszukaj i zapisz nazwy obrazków.

S	Z	C	Z	E	N	I	Ę	T	A	P	I	S	K	L	Ę
☺	☺	I	T	Y	G	R	Y	S	☺	R	Y	B	A	W	Ż
Ż	R	E	B	I	Ę	W	I	L	K	O	P	Ż	C	I	Y
S	☺	L	I	S	Z	Ż	Ó	Ł	W	S	U	U	Z	Ą	R
T	G	Ą	S	K	A	Ż	A	B	A	I	M	B	Ą	T	A
R	O	T	W	Ż	J	A	G	N	I	Ę	A	R	T	K	F
U	S	K	Ą	U	Ą	S	Ł	O	N	I	Ą	T	K	O	A
Ś	A	O	Ż	K	C	K	O	C	I	Ą	T	K	O	☺	☺

.....

.....

.....

.....

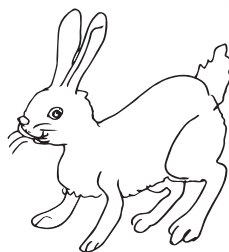
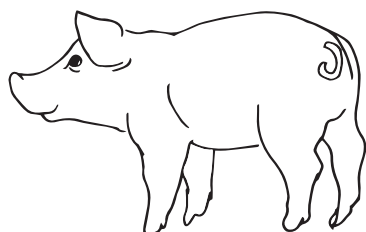
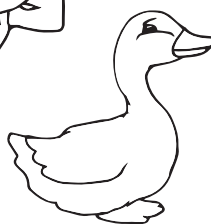
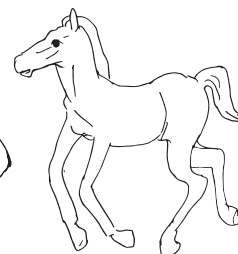
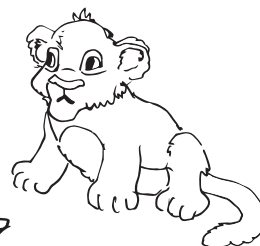
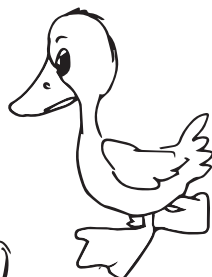
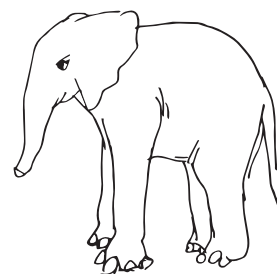
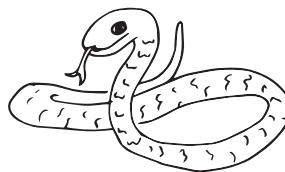
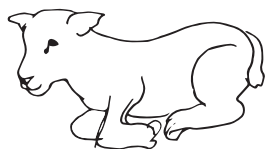
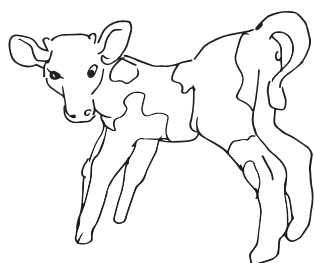

Uzupełnij luki w wyrazach. Pokoloruj pola zgodnie z opisem.

ą - zielony, ę - żółty, om - czerwony, on - niebieski, en - fioletowy.

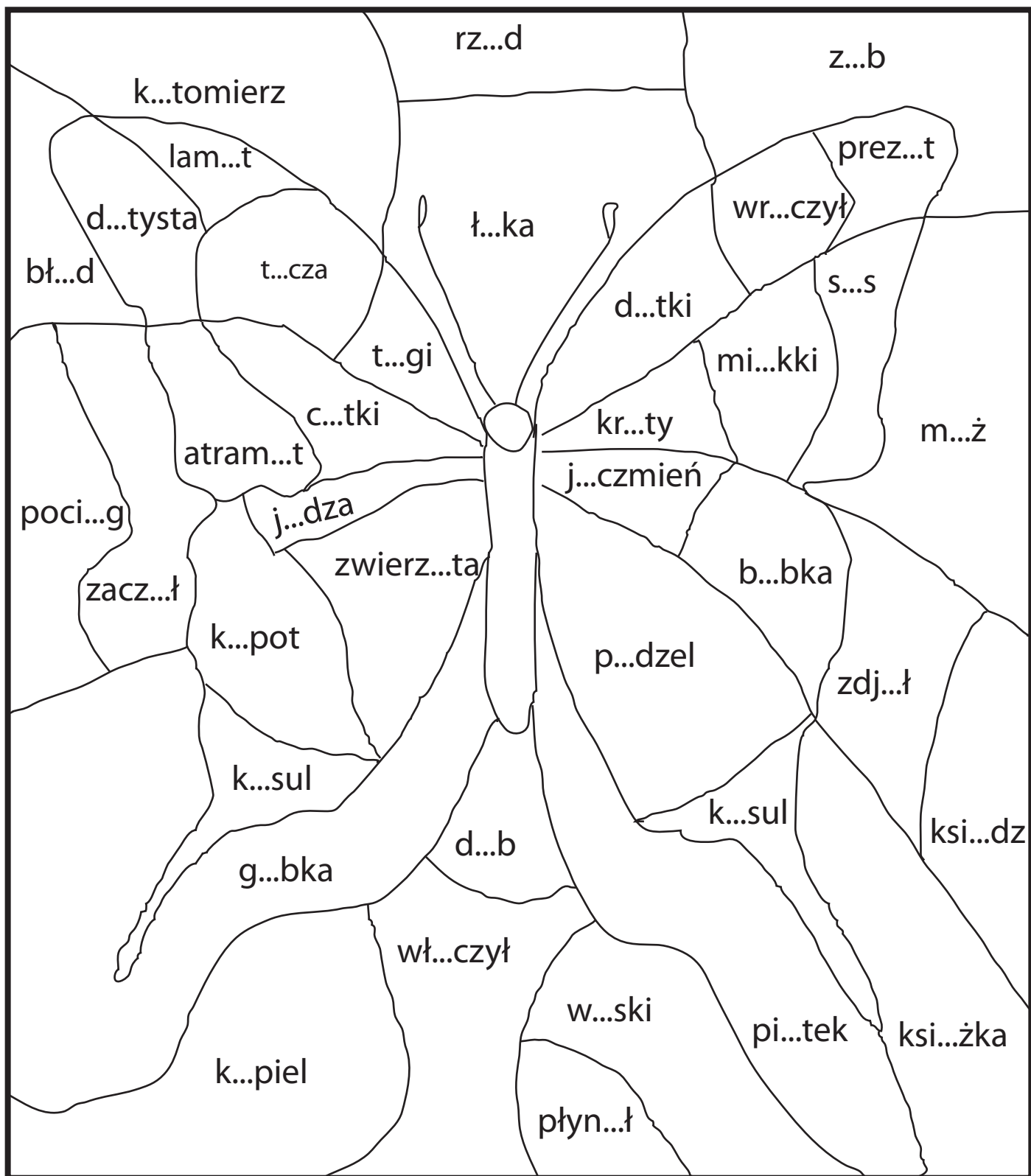

Głoski miękkie

Rozwiąż krzyżówkę obrazkową. Odczytaj hasło.

Pamiętaj, aby dwuznaki wpisywać w jedno okienko.

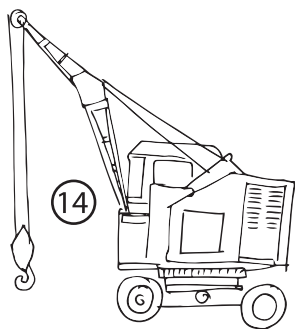

14

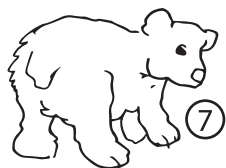

7

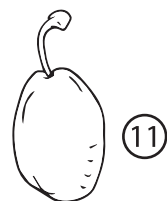

11

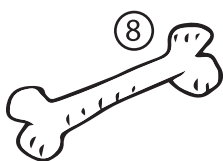

8

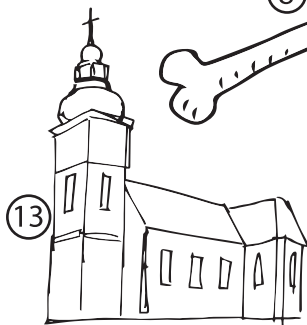

13



10



9

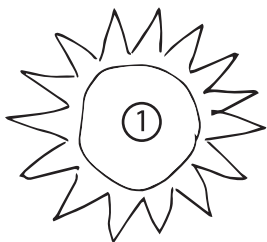

1



2



12

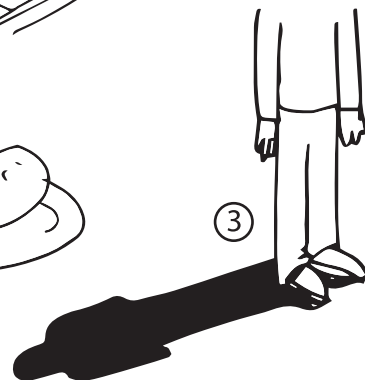

3

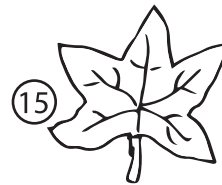
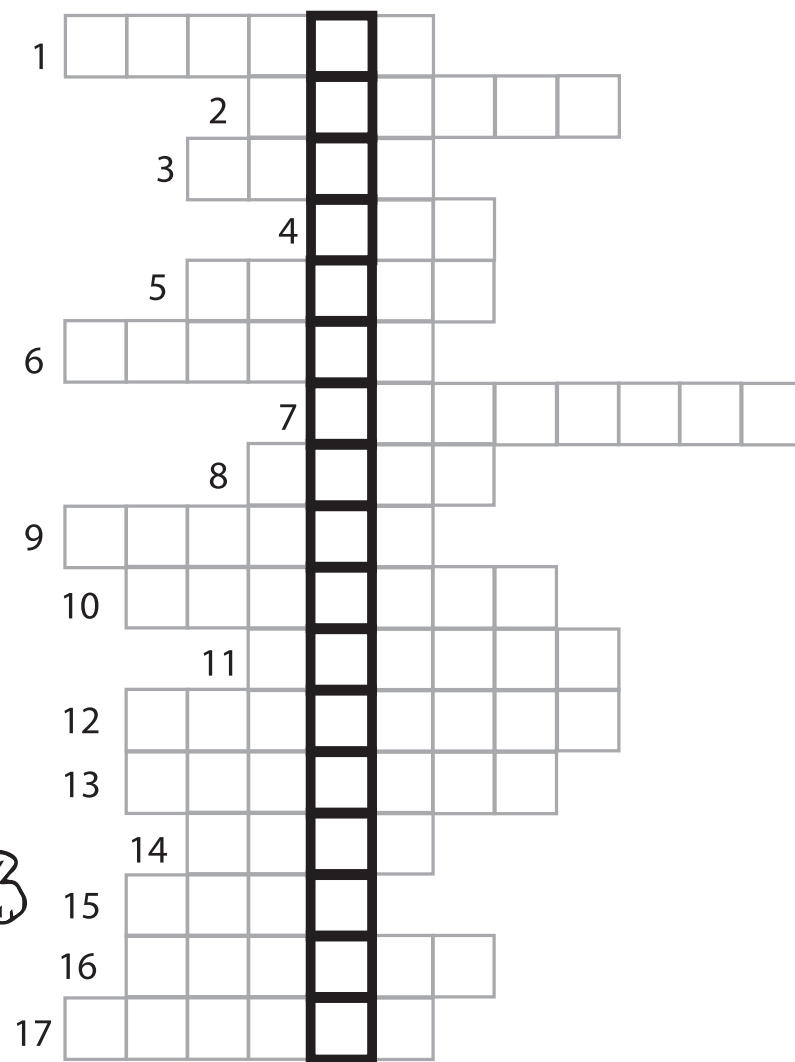

15

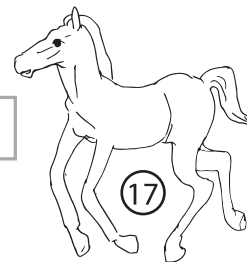

17



4



16

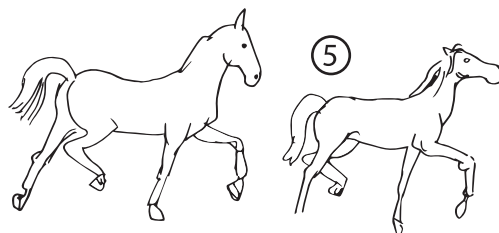

5

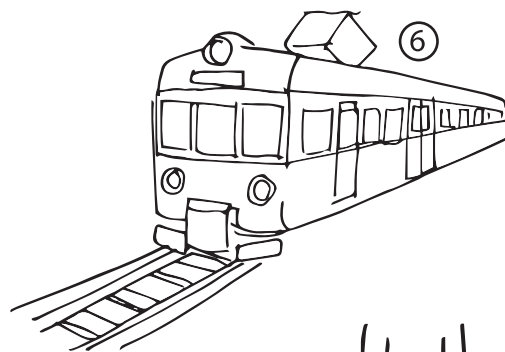

6

--	--	--	--	--	--	--	--	--	--	--	--	--	--	--	--	--	--	--	--

HASŁO





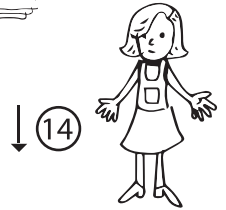
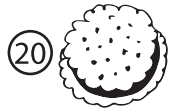
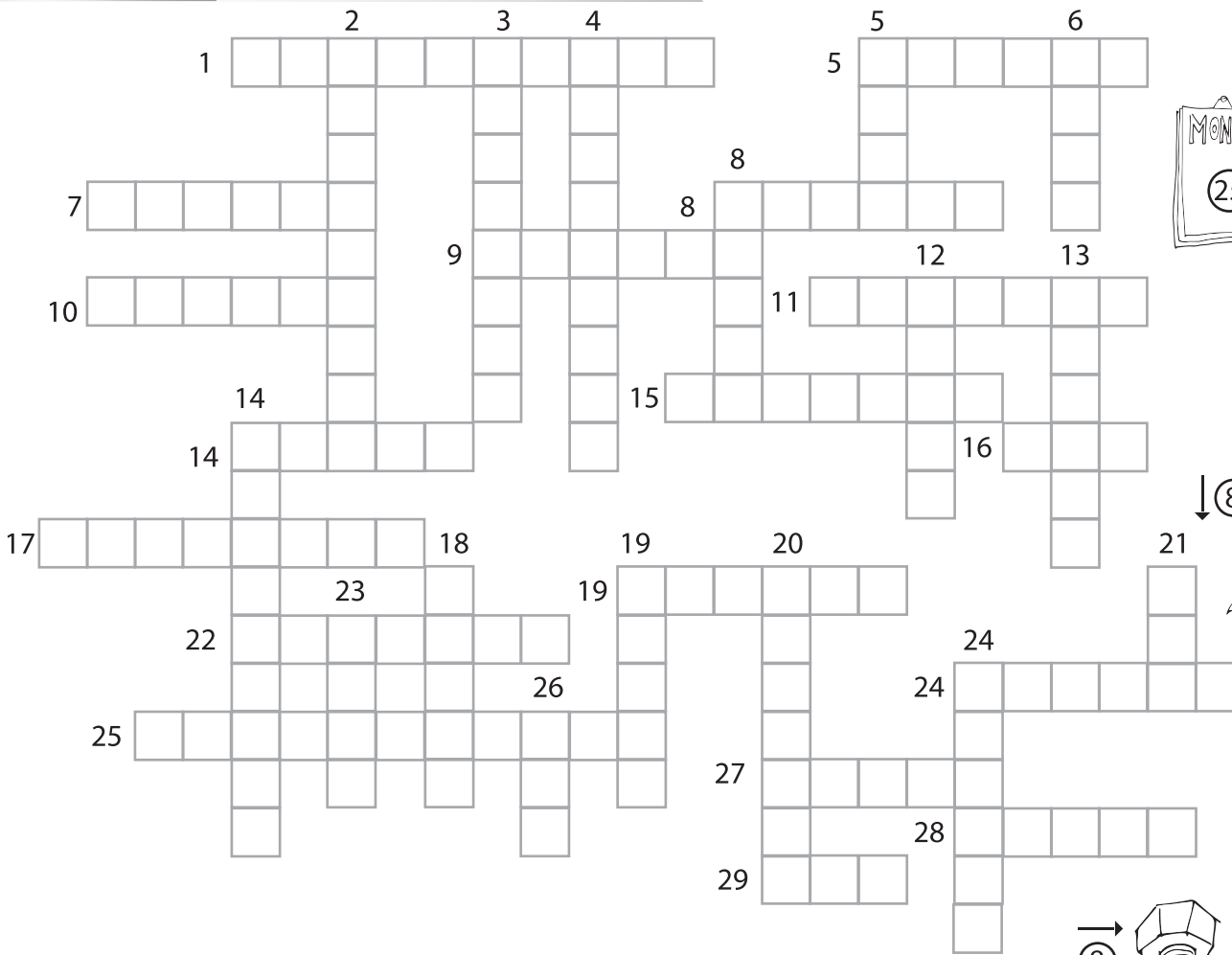



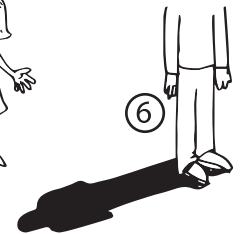
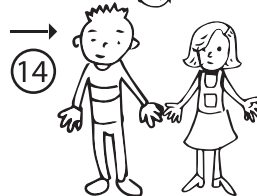
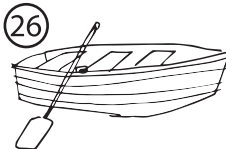
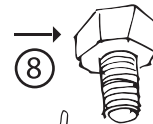
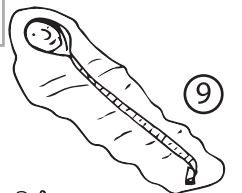

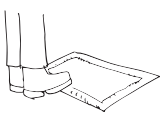

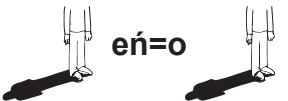

Rozwiąż krzyżówkę.

Pamiętaj, aby dwuznaki wpisywać w jedno okienko.

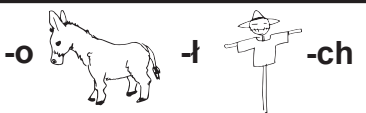

.....  
↓ 8 popielcowa

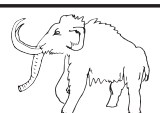

 w=ś -z -mr ①	 -ra ①7
 tnik=ci ⑤	 -j -stko ①8
 r=l -a ↓ ⑤	 ba -o -n → ①9
 -suk -stud ⑦	 pr=b l=ś ↓ ①9
 eń=o eń=a ⑩	 -o -li e=och ②2
 -o -ł -ch ⑪	 mi +ć → ②4
 k=d -k ⑬	 ca=tuś ②7
 t=sia ⑮	 pa=sia ②8



Odnajdź zapisane wyrazy.



Odnajdź i zapisz imiona.

M	A	R	Y	Ś	K	A	J	A	Ś
A	N	Y	S	K	A	B	O	☺	G
C	I	S	T	U	Ś	A	A	F	R
I	A	I	A	B	K	Ś	S	R	Z
E	☺	U	Ś	U	A	K	I	A	E
K	R	Z	Y	Ś	☺	A	A	N	Ś
Z	O	S	I	A	L	U	S	I	A
M	A	Ł	G	O	S	I	A	O	☺

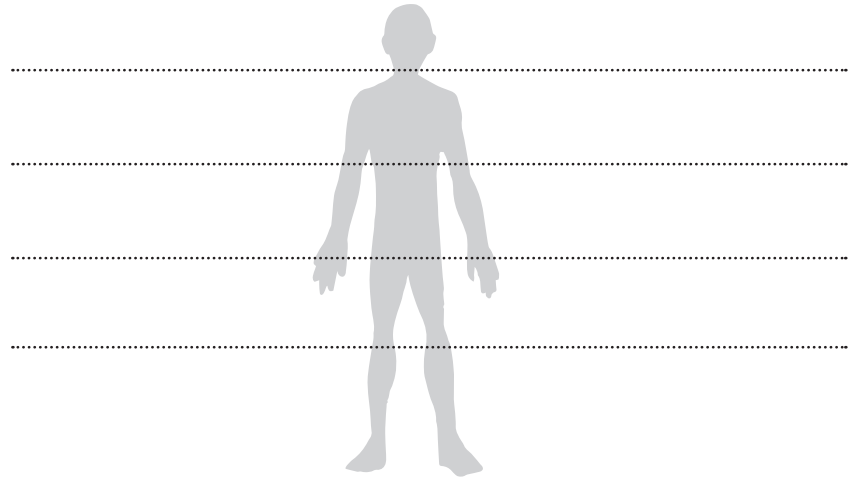

Odnajdź i zapisz nazwy roślin.

P	O	M	A	R	A	Ń	C	Z	A
O	C	Z	E	R	E	Ś	N	I	A
Z	G	O	Ż	D	Z	I	K	E	D
I	Ś	W	I	E	R	K	Ś	M	Y
O	W	I	Ś	N	I	A	L	N	N
M	Z	I	O	Ł	A	☺	I	I	I
K	J	A	Ś	M	I	N	W	A	A
A	R	O	N	I	A	☺	A	K	☺



Odnajdź i zapisz nazwy zwierząt.

N	I	E	D	Ż	W	I	E	D	Ż
D	Ś	K	Z	R	O	S	I	O	Ł
A	L	O	I	E	J	E	L	E	Ń
N	I	Ń	Ę	B	O	C	I	A	N
I	M	R	C	A	☺	G	Ę	Ś	☺
E	A	Y	I	K	S	T	R	U	Ś
L	K	Ś	O	J	A	G	N	I	Ę
Ł	O	Ś	Ł	P	R	O	S	I	Ę

